

# WALL-Y TECHNICAL MANUAL

THE GRID FOR VERTICAL GREEN

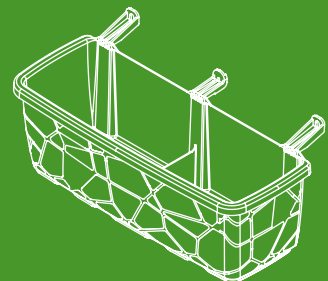
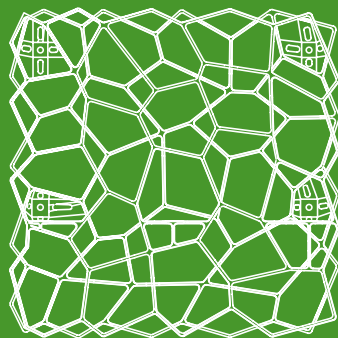
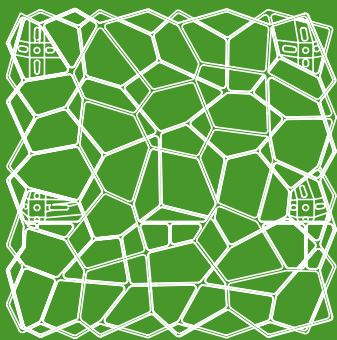

# INDEX

## WALL-Y TECHNICAL MANUAL

<b>1.</b>	<b>Introduction</b>	<b>P. 5</b>
1.1	Generalities	
1.2	Use of the product	
1.3	Functionality	
1.3.1	Support	
1.3.2	Design	
1.3.3	Insulation	
<b>1.4</b>	<b>Components</b>	
1.4.1	WALL-Y the Grid	
1.4.2	Pot	
1.4.3	Fixing systems	
<b>2.</b>	<b>Material and manufacturing</b>	<b>P. 6</b>
2.1	Material	
2.2	Manufacturing process	
<b>3.</b>	<b>Technical characteristics</b>	<b>P. 7</b>
3.1	WALL-Y	
3.2	Pot	
3.3	Safety measures	
<b>4.</b>	<b>Transport and storage</b>	<b>P. 8</b>
<b>5.</b>	<b>Installation and maintenance</b>	<b>P. 9</b>
5.1	Preliminary evaluation	
5.2	Installation process	
5.2.1	WALL-Y grid installation	
5.2.2	Installation of the pots	
5.3	Automatic irrigation	
5.4	Ground planting	
5.5	Greening	
5.6	Maintenance	

## **APPENDIXES**

**P. 12**

**APPENDIX A - MATERIAL SAFETY DATA**

**P. 13**

**APPENDIX B - INSTALLATION ON SUPPORTING STRUCTURES**

**P. 16**

**CASE A - HORIZONTAL AND VERTICAL BARS**

**P. 13**

**CASE B - STRUTS AND BRACKETS**

**P. 16**

# TECHNICAL DATA

# 1. INTRODUCTION

## 1.1 GENERALITIES

WALL-Y is a moulded grid in virgin HD PE, designed for the creation of green walls or for the creation of design structures. The element is fixed directly to the wall or to a specific structure with fixing systems suitably sized.

## 1.2 USE OF THE PRODUCT

The WALL-Y grid is used for the following systems:

- Support for climbing plants (green walls);
- Separation walls between rooms;
- Design works.

## 1.3 FUNCTIONALITY

### 1.3.1 SUPPORT

The grid structure has been designed to allow climbing plants to grow and plant optimally. The spacing between the fixing points on the wall ensures maximum system stability.

### 1.3.2 DESIGN

The particular geometry of the grid and the lively colouring, possible only with the use of virgin material, make the element pleasant to see even in the absence of a vegetal covering.

### 1.3.3 INSULATION

The grid is designed to be 2.5 cm apart from the wall, allowing a minimum gap for ventilation to be created. The green wall contributes to the thermal and acoustic insulation of the building, also reducing pollutants in the atmosphere.

## 1.4 COMPONENTS

### 1.4.1 WALL-Y GRID

WALL-Y grid is available in only one size with plan dimensions 58x58 cm and a total thickness of 7.5 cm. The available colours are green and white, but on request it can also be produced with a different colour, by adding the plastic material. The cells are irregularly shaped and are arranged on 2 superimposed levels. The grid is equipped with 4 prearrangements for wall mounting.

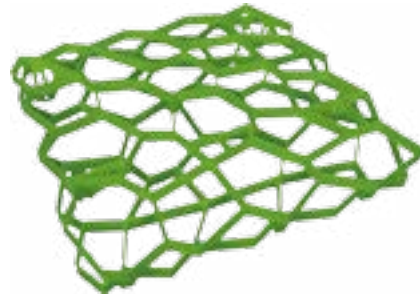

### 1.4.2 THE POT

In addition to the grid, it is possible to have a pot for the planting of vegetal species at altitude. The pot is rectangular, with dimensions 58x22xH=20 cm, and it is provided in the same color of the grid. A theme that recalls the grid's weft is printed in the outer walls. The pot is equipped with 3 hooks: 2 external hooks provided with a hole in proximity of the fixing points and a central one that fits into the grid, in order to provide a greater stability to the grid-pot connection.



### 1.4.3 FIXING SYSTEMS

The choice of the fixing system varies according to the type of wall or support in which you want to install WALL-Y. Variable length metal expansion anchors are generally used. Geoplast's Technical Unit is able to provide the technical assistance necessary to identify the most suitable anchorage system.

## 2. MATERIAL AND MANUFACTURING

### 2.1 MATERIAL

WALL-Y is made of high density polyethylene (HD PE), 100% virgin.

The material is chemically inert and does not release substances into the environment. It has been stabilized to UV rays in order to ensure its integrity over time.

Material properties are listed in the table.

CHARACTERISTIC	METHOD	U.D.M.	VALUE
MFI (190°C / 2,16 kg)	ASTM-D-1238	g/10'	7
Izod Resistance	ASTM-D-256	J/m	100
Breaking Load	ASTM-D-638	MPa	17
Fusion temperature		°C	137
Density	ASTM-D-792	g/cm <sup>3</sup>	>0,96

Information related to safety in the use of the material are listed in Appendix A.

### 2.2 MANUFACTURING PROCESS

WALL-Y grid and its pot are made by injection moulding at the Geoplast plant in Grantorto (PD), Italy.

Geoplast Spa is a company with UNI EN ISO 9001:2000 quality certification.



# 3. TECHNICAL CHARACTERISTICS

## 3.1 WALL-Y

The technical characteristics of WALL-Y are reported in the table and in the dimensional drawings. (Figure 1). The product is green or white in colour, with a smooth surface without engravings, air bubbles or inclusions.

Product Code	FWLYGVE5858 (green) FWLYGBI5858 (white)
Length	58 cm
Width	58 cm
Total Thickness	7,5 cm
Grid Thickness	5 cm
Thickness of the fixing feet	2,5 cm
Weight	1,5 kg
Horizontal wheelbase fixing holes	49 cm
Vertical wheelbase fixing holes	28,5 cm
Diameter of the fixing holes	Ø10 mm
Dowels diameter	Ø8 mm

The grids must never be cut, reduced or modified. If this happens, Geoplast Spa is not responsible for the system's failure.

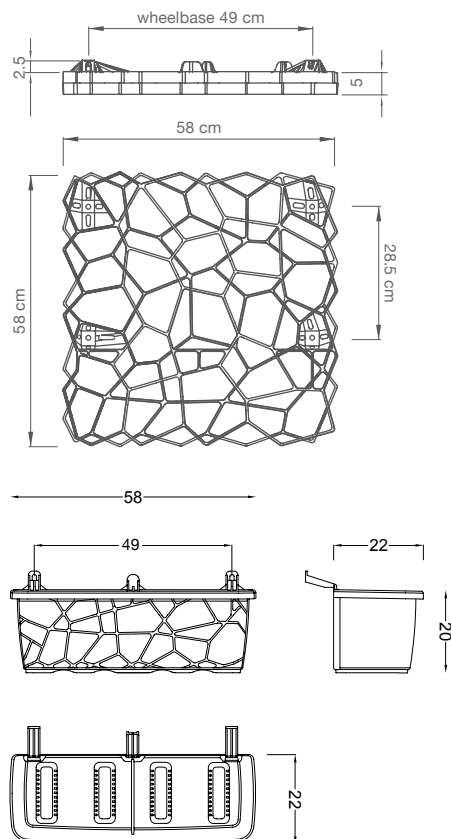

Figure 1: Dimensional drawings

## 3.2 POT

The characteristics of the accessory are shown in the table and dimensional drawings (Figure 1). The product is green or white in colour, with a smooth surface without engravings, air bubbles or inclusions.

Product Code	FWLYVVE0020 (green) FWLYVBI0020 (white)
Length	58 cm
Width	22 cm
Height	20 cm
Capacity	20 l
Weight	1,2 kg
Maximum load applied vertically permissible	80 kg
Horizontal wheelbase fixing holes	49,5 cm
Dowels diameter	Ø10 mm
Maximal breaking load	180 kg

The pot must be hooked to the grid and fixed with the dowels in proximity of the 2 external hooks. The fastening with dowels is compulsory.

The pot is necessary when you want to plant the climbers at altitude.

## 3.3 SAFETY MEASURES

The product must be laid manually. The installation can be carried out by a single operator because the weight of the elements is less than the maximum liftable weight in optimal conditions (ISO 11228).

When handling WALL-Y elements and pots, attention should be paid to the following risks:

- Risk of crushing during the mechanical handling of the pallets;
- Risk of crushing during break-up operations;
- Risk of detachment of elements from the wall if not properly secured;
- Risk of falling during installation, especially at heights that requires means or tools for the operator lifting.

## 4. TRANSPORT AND STORAGE

WALL-Y grids and trays are stored and transported in pallets; the packaging characteristics are as follows:

	<b>DIMENSIONS</b> cm	<b>ELEMENTS</b> n°	<b>SURFACE</b> m <sup>2</sup>
<b>WALL-Y</b>	120 x 120 x H=240	180	60
<b>POT</b>	100 x 120 x H=200	100	-

Mechanical means, like forklifts or cranes, equipped with lifting straps can be used for the unloading and handling of the pallets. For proper storage, it is recommended to choose a stable and as regular as possible surface; the product must remain protected from contact with fuels, lubricants, chemicals or acids. The following operations must be avoided once the elements are removed from the pallet:

- Incorrect storage (superimposition of pallets, elements jumbled together,...);
- Incorrect handling (elements thrown around, dragging,...);
- Contact or impact with sharp or blunt bodies (stones, blades,...).

**IMPORTANT:** Before installation, it must be checked that the elements are not damaged or defective (the characteristics described in paragraphs 3.1 and 3.2 must be observed). Avoid installation if there is any damage or defect in the grids or in the pots.



# 5. INSTALLATION AND MAINTENANCE

## 5.1 PRELIMINARY EVALUATION

Before the installation of the system, it is advisable to carry out a series of evaluations necessary for the correct installation and for obtaining an optimal result. Evaluations should relate to

- Type of wall or supporting structure where grids will be placed, in order to choose the correct fixing system;
- Connection to the hydraulic system to supply the irrigation system;
- Type of plant species to plant depending on the climatic conditions.

## 5.2 INSTALLATION PROCESS

### 5.2.1 INSTALLATION OF THE WALL-Y GRID

An 8 mm dia. expansion dowel and a 20 mm dia. washer are recommended for fastening.

The length and type of dowel must be chosen according to the type of support (material, concrete, etc.).

WALL-Y can also be installed:

- Above the coated cladding, using specific dowels that avoid the thermal bridge, chosen according to the thickness of the covering;
- On walls made of spritz beton, provided that the concrete layer is thick enough.

The composition of the concrete must also be checked to avoid problems of crumbling during the fastening phase.

It is recommended to proceed as follows:

- Orientation of the grid according to figure 2 and marking the dowels position with a marker pen;
- Drill holes with a Ø8 mm diameter and fix the grid to the wall with dowels and washers.

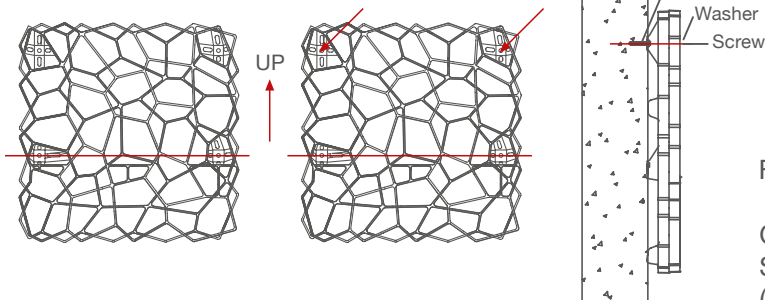

Figure 2: Installation of Wall-Y grid.

The grids installation order goes from bottom to top, and from right to left.

Grids with pots have to be fixed with all 4 dowels, while grids without pot can be fixed with only 2 dowels placed at opposite corners.

See Appendix B for installation on supporting structures (not walls).

Please note that Geoplast Spa is not liable for any damage to the system if the above regulations are not observed.

### 5.2.2 POTS INSTALLATION

The use of a Ø10 mm extension dowel and a Ø20 mm washer is recommended for fixing; 2 metal slots are also supplied with the pot, in order to use them for fixing.

It is recommended to proceed as follows:

- Hook the pot as shown in figure 3.
- Care must be taken to guarantee the insertion of the 2 supports inside the appropriate spaces of WALL-Y grid.
- Proceed with the fixing of the 2 lateral supports using the slots provided, the dowel and the washer.

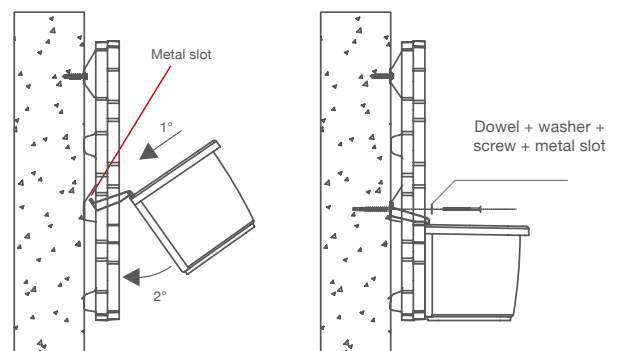

Figure 3: Pot Installation

Only one pot per grid.

See Appendix B for installation on supporting structures (not walls).

Please note that Geoplast Spa is not liable for any damage to the system if the above requirements are not observed.

## 5.3 AUTOMATIC IRRIGATION

The irrigation system indicated for the vertical green wall with WALL-Y is a drip irrigation system.

The core of the plant is an electrical control unit connected directly to the water supply network, programmable according to the timetables or flow rate to be supplied to the distribution network.

This mesh is provided with 1/2 "diameter flexible tubes, connected to the pots through 1/4" diameter extensions, which can be easily integrated to the grid structure and locked to it with clamps. The tubes supply the drippers, placed inside the pot with special stakes embedded in the ground and provided with a flow-rate manual regulation system.

It is also advisable to equip the system with one or more rain/ground rainfall sensors:

- In the case of an external wall, the installation of 1 sensor is sufficient;
- In the case of an internal wall, where excessive irrigation can cause damage to the internal environments, it is convenient to install at least 2 sensors in 2 different places.

## 5.4 GROUND PLANTING

The greening of WALL-Y is possible to the growth of the chosen plants directly from the ground. In this case, climbers can be planted directly in the soil, or alternatively in flower boxes with sufficient capacity to support the development of the root system over time.



















## 5.5 GREENING

A fundamental requirement to obtain an optimal result is the careful selection of plant species to be planted according to the climatic conditions of the site (sunlight exposure, temperature, humidity, indoor/outdoor installation,...).

For a quick and uniform greening of the wall, we recommend to follow these tips:

- Install 1 pot every 4 grids vertically and every 1-2 grids horizontally (depending on the vigour of the chosen plant species);
- Plant at least 3 plants per pot;
- Use a substrate provided by a mix of vegetable soil and volcanic lapillus;
- Provide the system with an efficient irrigation system.

The specific characteristics of certain plant species are shown in the table below.

Species	Category	Climatic needs	Exposure	Water needs	Flowering period	Pot or soil	Type of vegetation soil
<b>Jasminum</b> Jasmine	Evergreen or deciduous climbing plant	Does not stand intense cold, full sun	 	Regular irrigation	Seasonal (depends from variety)	Soil	Universal
<b>Rhincospermum</b> jasminoides	Sarmentous evergreen climbing plant	Resistant to cold	 	Regular irrigation, suffer water stagnation	April-July	Pot/Soil	Universale or silty
<b>Clematis</b> (diff. varieties)	Sarmentous evergreen or deciduous	Mild resistance to cold, avoid excessive heat	 	Abundant irrigation, suffer water stagnation	Spring-summer	Soil	Universal or slightly alkaline, well drained
<b>Hedera-Araliaceae</b> Hedera (diff. varieties)	Evergreen climbing plant	Resistant to cold	 	Suffer water stagnation	Autumn	Pot/Soil	Universal, well drained
<b>Rosaceae</b> Rosa climbing rose (diff. varieties)	Sarmentous, or deciduous climbing plant	Good hardness and mild resistance to cold	 	Abundant irrigation in spring/summer	June-autumn	Pot/Soil	Universal, well drained
<b>Passifloraceae</b> (Passion flower)	Deciduous climbing plant	Does not stand cold and high temperatures		Normal irrigation, increase in summer	June-September	Pot/Soil	Universal, well drained
<b>Parthenocissus-Boston ivy</b> (diff. varieties)	Deciduous climbing plant	Resistant to cold	 	Does not stand droughts	May-July	Soil	Universal, well drained
<b>Lonicera caprifolium</b> Honeysuckle	Deciduous climbing plant	Mild resistance to cold	 	Normal irrigation, increase in summer	April-September	Soil	Universal, well drained
<b>Wisteria sinensis</b> Wisteria	Deciduous climbing plant	Good hardness and mild resistance to cold	 	Normal irrigation, increase in summer	May-June	Soil	Clayey
<b>Nyctaginaceae</b> Bougainvillea (diff. varieties)	Evergreen climbing plant	Does not stand cold (not resistant to <10° C)		Mild irrigation	Spring-autumn	Pot/Soil	Universal, well drained
<b>Dipladenia</b> (diff. varieties)	Evergreen climbing plant	Does not stand	 	Normal irrigation	Early summer	Pot/Soil	Soft, well drained
<b>Ficus Repens</b> Climbing fig	Evergreen climbing plant	Does not stand		Mild irrigation	-	Pot/Soil	Soft, well drained

## 5.6 MAINTENANCE

The main operations to be carried out for the maintenance of the system are mainly related to the maintenance of the plant species. The grids and the pots do not require special attention once properly installed. The following operations are recommended:

- Periodic irrigation, according to the needs of the planted species, if no irrigation system is present;
- Regular maintenance and check of the functioning of the irrigation system;
- Possible pruning of the plants;
- Plant restoration if necessary.

It is recommended to carry out these safety measures, in particular with installations at height, where it is necessary the use of structures or lifting means.





# APPENDIXES

# APPENDIX A

## MATERIAL SAFETY DATA

### COMPOSITION / POLYMER INFORMATION

INGREDIENTS	N° C.A.S.	%
Polyethylene	9010-79-1	97-99
Additives	Not available	1-3

### HAZARDOUS COMPONENTS

This product does not fall within the definition of hazardous material provided by EEC 1999/45 and subsequent regulatory measures.

Physical state: Solid

Problem: If the polymer is subjected to temperatures close to the melting point (>130°C) it can produce irritating vapours to the respiratory system and eyes.

### FIRST AID MEASURES

Inhalation of decomposition or combustion products: Keep the patient calm, move the patient to fresh air and call for medical help.

Skin contact: parts that come into contact with molten material must be quickly brought under running water and the doctor must be contacted.

Eye contact: flush eyes for at least 15 minutes under running water while holding the eyelids open. Contact with material particles does not present any particular danger, except for the possibility of abrasion wounds. Fine particles can cause irritation.

Ingestion: No particular measures to be taken.

### FIRE PREVENTION MEASURES

Extinguishing materials: water, foam or dry extinguishing materials.

Unsuitable extinguishing materials: none.

Substances released in the event of fire: carbon dioxide (CO<sub>2</sub>) and steam mainly in the event of fire. Other substances that may form: carbon monoxide (CO), monomers, other degradation products.

Special protective equipment: Wear breathing apparatus in case of fire.

Other requirements: Dispose of contaminated combustion slag and fire extinguishing material in accordance with local regulations.

### ACCIDENTAL RELEASE MEASURES

It is not classified as an hazardous material. It can be recycled, incinerated or disposed of in landfills in accordance with local regulations.

### STORAGE AND MANIPULATION

When the product is milled, the applicable dust regulations must be taken into account.

Keep it in a dry place.

### EXPOSURE CONTROL / PERSONAL PROTECTION

Respiratory tract protection: when in presence of respirable dust, P1 filters (DIN 3181) must be used.

Skin protection: no special precautions.

Eye protection: safety glasses in the presence of free particles.

### CHEMICAL-PHYSICAL PROPERTIES

Shape	Grids
Color	Green or white
Smell	Soft
Change in physical state	Melting temperature: 210 - 260°C Combustion temperature: above 300°C
Flammable properties	None
Density	0.96 kg/dm <sup>3</sup>
Solubility in water	Insoluble
Solubility in other solvents	Soluble in aromatic solvents

### STABILITY AND REACTIVITY

Conditions to avoid	Do not overheat to prevent thermal decomposition. The process begins at around 300°C
Thermal degradation products	monomers and other sub-products

### TOXICOLOGICAL INFORMATION

Acute toxicity: data not available (no animal experiments due to impossibilities related to product conformation).

Insoluble in water.

### **ECOLOGICAL INFORMATION**

Degradation in nature: no data available. Insoluble in water.

Behaviour and environmental purpose: the product is environmentally friendly because it is made of recycled plastic. It is not apparently biodegradable due to its water insolubility and consistency.

### **DISPOSAL CONSIDERATIONS**

Product 100% recyclable. It can be disposed of in landfills or incinerated in accordance with local regulations.

### **TRANSPORT INFORMATION**

It is not classified as dangerous for transport purposes.

### **REGULATORY INFORMATION**

It is not subjected to the CE marking.

# APPENDIX B

## INSTALLATION ON SUPPORTING STRUCTURES

### CASE A – HORIZONTAL AND VERTICAL BARS

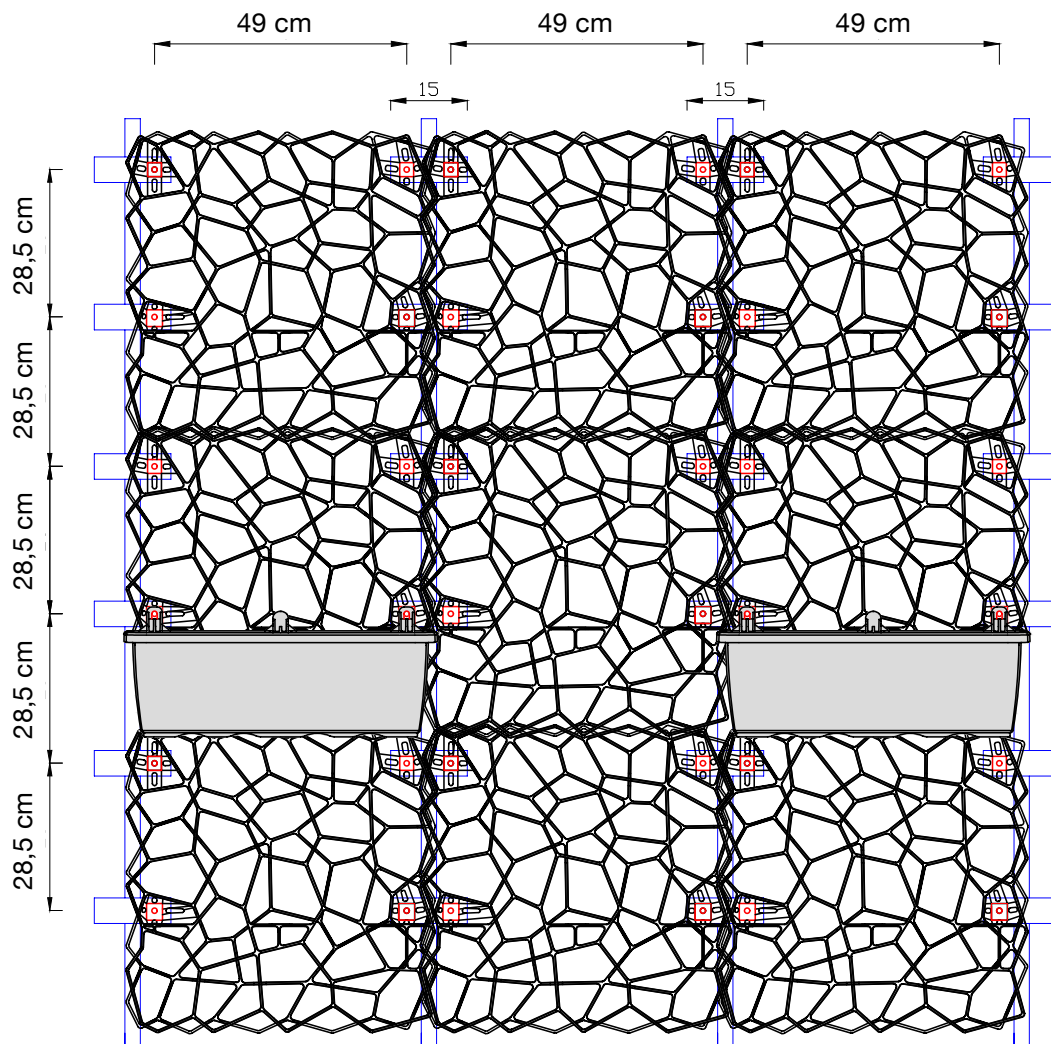

#### Fixing:

- 2 dowels per each grid without pot
- 4 dowels per each grid with pot



**CASE B – STRUTS AND BRACKETS**

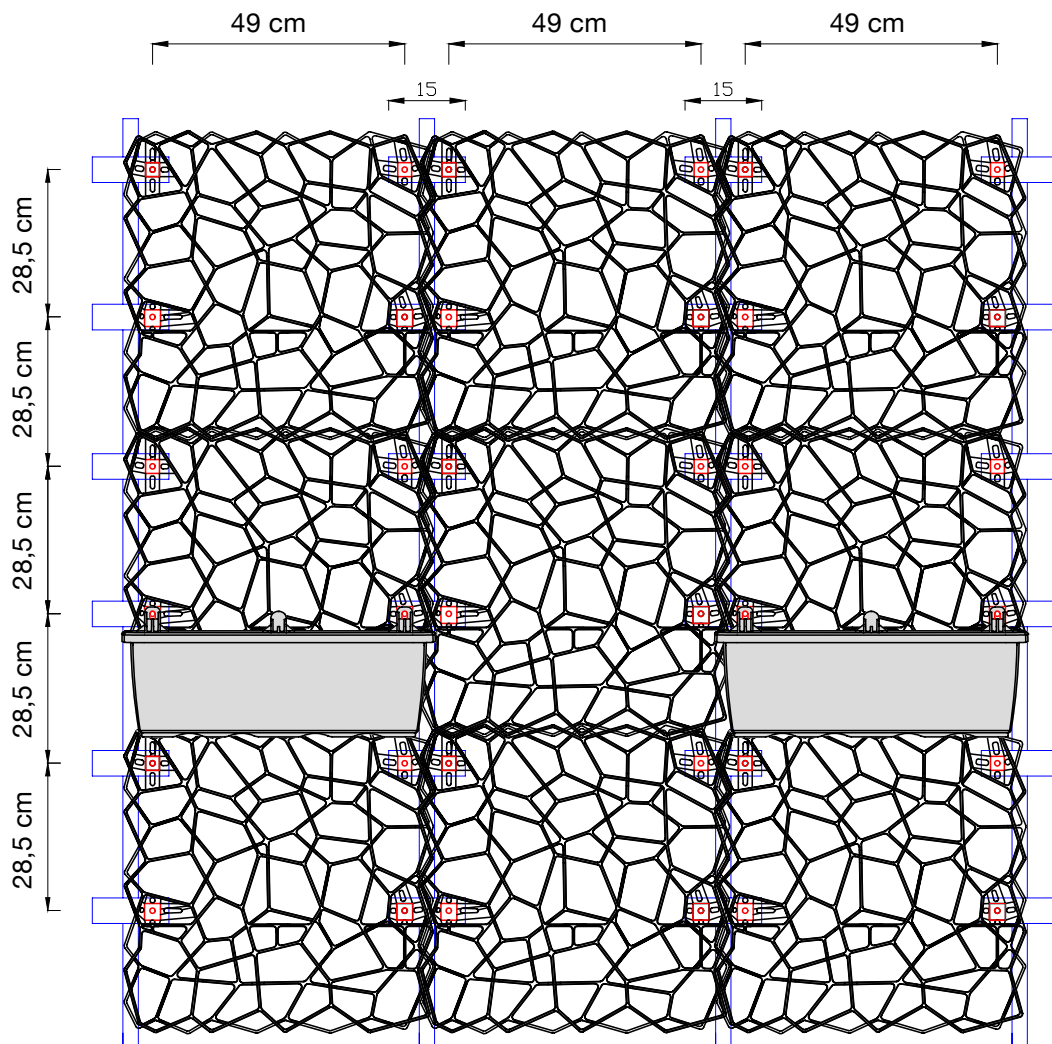

**Fixing:**

- 4 dowels per each grid without pot
- 4 dowels per each grid with pot







**Geoplast**  
Building beyond together

**Geoplast S.p.A.**

Via Martiri della Libertà, 6/8  
35010 Grantorto (PD) - Italy

Tel +39 049 9490289  
Fax +39 049 9494028

[Geoplast@Geoplast.it](mailto:Geoplast@Geoplast.it)

[Geoplast.it](http://Geoplast.it)



rev.001  
10/2017